

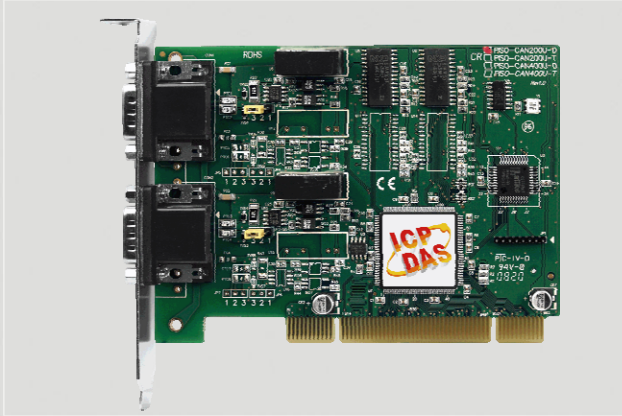

CAN Series Products



Universal PCI CAN Communication Card



PISO-CAN200U-D



PISO-CAN200U-T

The PISO-CAN200U can represent an economic solution of an active CAN board with universal PCI bus. It has 2 independent CAN bus communication ports with 5-pin screw terminal connector or 9-pin male D-sub connector, and has the ability to cover a wide range of CAN applications. Besides, PISO-CAN200U uses the new CAN controller Phillips SJA1000T and transceiver 82C250, which provide bus arbitration, error detection with auto correction and re-transmission function. It can be installed in both 3.3 V and 5 V PCI slot and supported truly “Plug & play”.

Features

- Compatible with CAN 2.0 parts A and B
- Fully compatible with ISO 11898-2 standard
- Support CAN baud from 10 kbps ~ 1 Mbps
- 2500 Vrms photo couple isolation on the CAN bus
- Universal PCI supports both 5 V and 3.3 V PCI bus
- Built-in jumper to select 120 Ω terminal resistor
- 3 kV galvanic isolation
- 2 independent CAN channels
- Direct memory mapping to the CAN controller
- Provide VB6.0, VC++6.0, Delphi, BCB6.0 demos
- LabView/DASYLab driver
- Driver support Windows 98/ME/NT/2K/XP/7

Hardware architecture

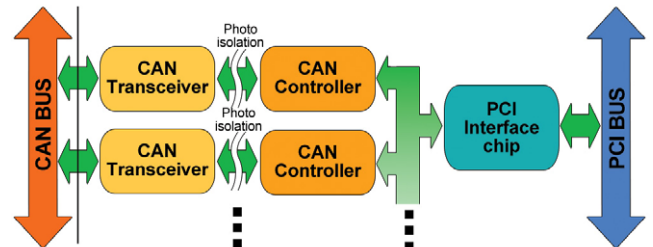

Pin Assignments

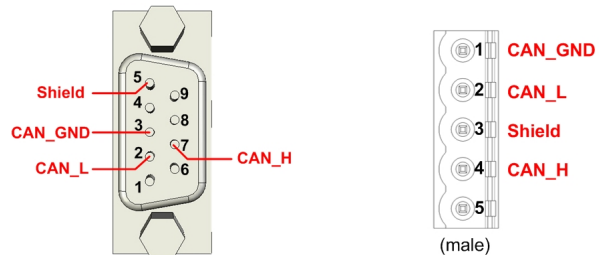

9 pin male D-sub connector 5 pin screw terminal connector

Software Layer

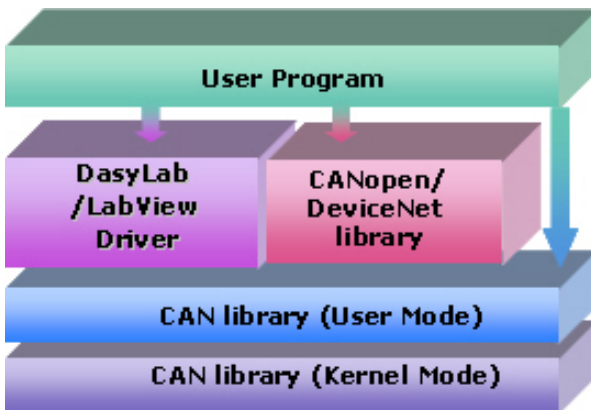

Terminal Resistor

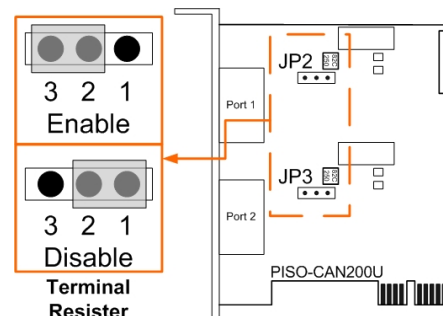



Hardware Specifications

Model Name	PISO-CAN200U-D	PISO-CAN200U-T
Bus Interface		
Type	Universal PCI, 3.3 V and 5 V, 33 MHz, 32-bit, plug and play	
CAN Interface		
Controller	NXP SJA1000T with 16 MHz clock	
Transceiver	NXP 82C250	
Channel number	2	
Connector	9-pin male D-Sub	5-pin screwed terminal block
Baud Rate (bps)	10 k, 20 k, 50 k, 125 k, 250 k, 500 k, 800 k, 1 M (allow user-defined baud rate)	
Terminator Resistor	Jumper for 120 Ω terminator resistor	
Power		
Power Consumption	250 mA @ 5 V	
Software		
Driver	Windows 98/ME/NT/2K/XP/7, Linux 2.6.37, LabView, DASyLab	
Library	VB 6.0, VC++ 6.0, BCB 6.0, Delphi 4.0	
Mechanism		
Dimensions	126mm x 22mm x 85mm (W x L x H)	
Environment		
Operating Temp.	0 ~ 60 °C	
Storage Temp.	-20 ~ 70 °C	
Humidity	5 ~ 85% RH, non-condensing	

Utility

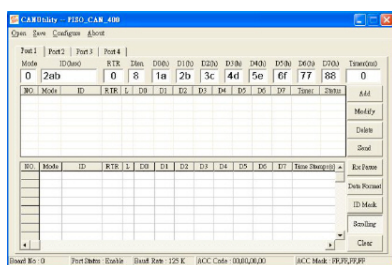

- Can be a CAN system monitor tool with CAN cards
- Can test CAN cards
- Send/Receive/Record CAN messages
- Provide cyclic transmission function
- Record the CAN messages with filter ID with time stamp

Flow Diagram for Applications

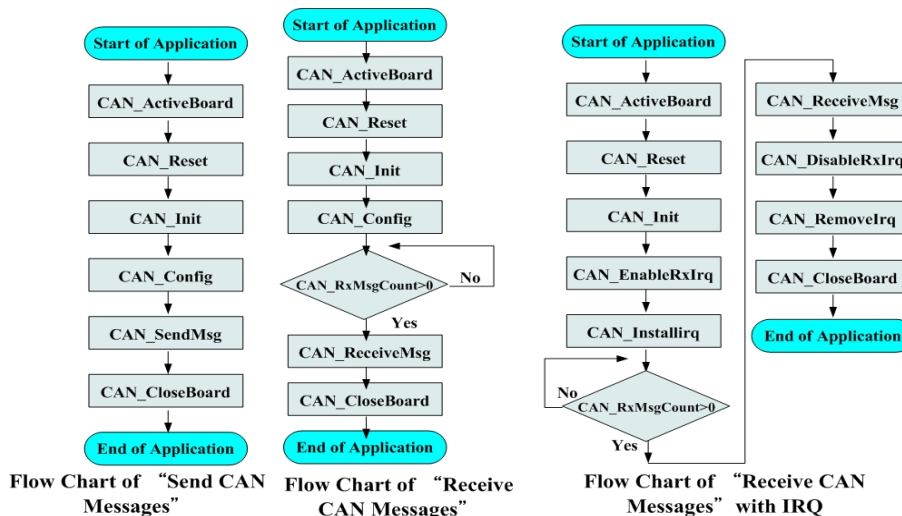

Ordering Information

PISO-CAN200U-D CR	2-Port Isolated Protection CAN Communication Board with 9-pin D-sub connector (RoHS)
PISO-CAN200U-T CR	2-Port Isolated Protection CAN Communication Board with 5-pin Screw Terminal Connector (RoHS)